

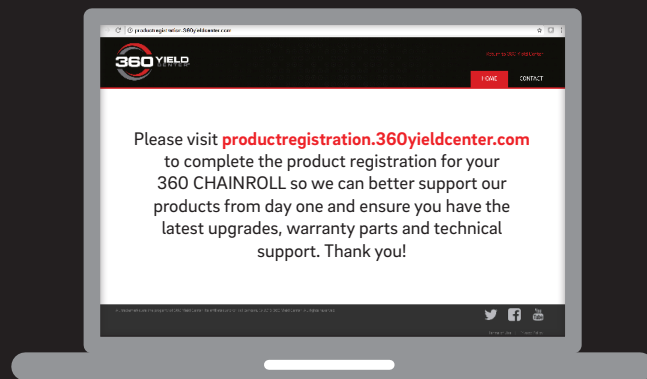

INSTRUCTIONS 360 CHAINROLL™

JOHN DEERE 600 SERIES 2008-2012
SERIAL #s PRE - 745101

360 CHAINROLL™ REGISTRATION



360YIELDCENTER.COM

V7 - 12.14.2017

INSTRUCTIONS

360 CHAINROLL

JOHN DEERE 600 SERIES 2008-2012

PARTS OVERVIEW

360 CHAINROLL ROW UNIT KIT - JD 600 SERIES 2008-2012 (PART NO. 451201)

- + Left 360 CHAINROLL (Part No. 450201)
- + Right 360 CHAINROLL (Part No. 450211)
- + (2) M20 Flange Nuts (All Models)
- + (8) M6 Cap Screws or (4) M10 Cap Screws

360 CHAINROLL RESIDUE KNIVES (PART NO. 450220)

- + 360 CHAINROLL Residue Knife Left (Part No. 450222)
- + 360 CHAINROLL Residue Knife Right (Part No. 450221)

NOTE: IF YOU PURCHASED THE 360 CHAINROLL RESIDUE KNIFE CHOPPING HEAD KIT (PART NO. 450290) THAT WILL INCLUDE THE FOLLOWING:

- + 360 CHAINROLL Residue Knife (Chopping Head) Left (Part No. 450222)
- + 360 CHAINROLL Residue Knife (Chopping Head) Right (Part No. 450291)

ROLL ORIENTATION

IMPORTANT: Left ("L") and Right ("R") are defined from the perspective of the operator's seat. Make sure the rolls are properly aligned and intermeshed when installing them onto the drive shafts by aligning the yellow timing marks as shown in the figure below. Once installed, if the rolls are making contact with each other, remove rolls and rotate the shafts 180 degrees and reinstall the rolls. If the rolls continue to make contact with each other after rotating the shafts a full 360 degrees, contact your John Deere dealer to have the shaft alignment inspected.

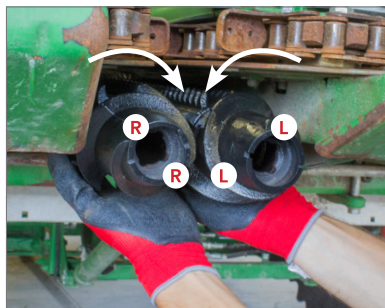
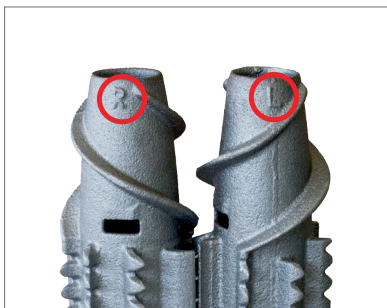

QUESTIONS

Call our Product Support team at **888-512-4890**.

I.

OEM STALK ROLL REMOVAL

PART 1: REMOVE RESIDUE KNIVES

TOOLS AND PARTS REQUIRED:

+ 18mm Socket

FIGURE 1

STEP 1 Remove the (4) M12 flange head cap screws.

NOTE: Retain screws for installation of new residue knives.

STEP 2 Repeat Step 1 for the opposite side.

PART 2: REMOVE DRIVE SHAFT NUTS

TOOLS AND PARTS REQUIRED:

+ 30mm (1-3/16") or 27mm (1-1/16") Socket

NOTE: Two styles of flange nuts may be encountered (see FIGURE 2)

FIGURE 3

STEP 1 Remove the nut and rounded washer (if equipped) from drive shaft. Discard nut only.

NOTE: Retain washer for installation of new rolls, inspect for corrosion and damage. If no washer is equipped, purchase from your local John Deere dealer (Part No. HXE24179).

STEP 2 Repeat Step 1 for adjacent roll.

PART 3: REMOVE OEM STALK ROLLS

TOOLS AND PARTS REQUIRED:

+ 360 CHAINROLL Puller or Equivalent

STEP 1 Orient old stalk rolls by manually turning the header until pulling features are facing towards stripper plate gap. Improve accessibility by opening up stripper plates, if needed.

NOTE: Where applicable, use the 360 CHAINROLL Puller or Equivalent to complete steps 2-5. Otherwise, use other means to remove the rolls.

FIGURES 4

STEP 2 Ensure that T-handle is fully retracted, then attach puller arms to pulling features on the castings, as shown. **Reference Puller Insert, Page 9.**

STEP 3 Apply initial tension on puller by tightening the 1-1/2" hex feature.

STEP 4 Extend hydraulic puller by turning T-handle, as shown.

NOTE: If necessary use the striking lug for added force after ram is fully extended.

STEP 5 Repeat steps 1-4 for adjacent roll.



FIGURE 1

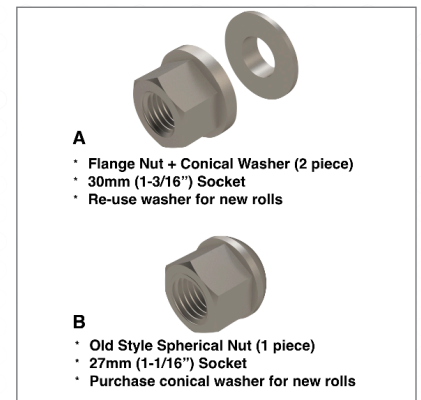

FIGURE 2



FIGURE 3

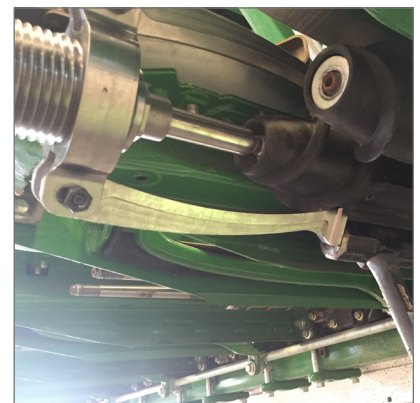

FIGURE 4

II. 360 CHAINROLL INSTALLATION

PART 1: INSTALL 360 CHAINROLL

TOOLS AND PARTS REQUIRED:

- + 360 CHAINROLL Left
- + 360 CHAINROLL Right

FIGURE 13

NOTE: Remove all dirt and corrosion from shaft taper, splines and threads. Inspect shaft for wear, damage and straightness. Replace as necessary.

FIGURE 14

STEP 1 Orient 360 CHAINROLL such that the opposed facing flutes [cutting and retaining] are contained within the adjacent facing flutes [cutting and chaining].
Reference cutaway in Figure 14.

STEP 2 Use one hand to support the 360 CHAINROLL on the bottom side. With the other hand, grip the auger end of the 360 CHAINROLL.

FIGURE 15

STEP 3 Install both rolls simultaneously onto the drive shafts, taking note of the shaft keyway orientation and **ensuring that the cutting flutes remain interlocked.**

STEP 4 Continue to slide the rolls back onto the drive shafts until fully seated and the end of the drive shaft is flush with the end of the nose cone.



FIGURE 13



FIGURE 14



FIGURE 15

II.

360 CHAINROLL INSTALLATION

PART 2: TIGHTEN 360 CHAINROLL

TOOLS AND PARTS REQUIRED:

- + 30mm (1-3/16") Socket
- + (2) M20 Flange Nuts
- + (8) M6 Cap Screws and M5 Hex Drive or
(4) M10 Cap Screws and M8 Hex Drive
- + Torque Wrench
- + Breaker Bar

NOTE: **IMPORTANT:** Ensure that the cutting flutes remain intermeshed throughout installation.

FIGURE 16

STEP 1 Install the washers on the drive shafts flat face out.

NOTE: If no washer is equipped, purchase from your local John Deere dealer (Part No. HXE24179).

STEP 2 Install the provided M20 flange nuts onto the drive shafts.

NOTE: Place a wooden block between 360 CHAINROLL to prevent rotation during torqueing.

STEP 3 Tighten the M20 flange nut to 90ft-lbs (122Nm).

NOTE: M20 Flange nuts come from 360 Yield Center with single torqueing only pre-applied thread locker. In the case that a flange nut is removed after initial torqueing, a medium strength thread locker must be applied to threads prior to reinstalling and torqueing down to prevent loosening from vibration.

STEP 4 **IMPORTANT:** Manually turn 360 CHAINROLL a full revolution to ensure that no interferences exist.

FIGURE 17

STEP 5 Using a breaker bar, rotate the M20 flange nut an additional 60 degrees.

FIGURE 18

STEP 6 Install (8) M6 cap screws and torque to 14.5ft-lbs (20Nm) or the (4) M10 cap screws and torque to 67ft-lbs (90Nm).

NOTE: The hardware comes from 360 Yield Center with single torqueing only pre-applied thread locker. In the case that the hardware is removed after initial torqueing, a medium strength thread locker must be applied to threads prior to reinstalling and torqueing down to prevent loosening from vibration.



FIGURE 16

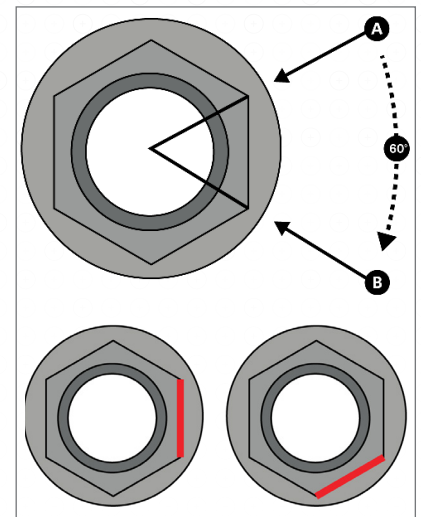

FIGURE 17



FIGURE 18

II. 360 CHAINROLL INSTALLATION

PART 3: REINSTALL RESIDUE KNIVES

TOOLS AND PARTS REQUIRED:

+ 18mm Socket

STEP 1 Install new 360 CHAINROLL Residue Knives or reworked OEM knives using the (4) M12 flange head cap screws. Start from the rear and do not fully tighten.

NOTE: Call your 360 Yield Center Dealer or 360 Yield Center Product Support Team for the Residue Knife Template.

FIGURE 19

STEP 2 Adjust spacing of the residue knife to approximately 1/4" clearance from the 360 CHAINROLL. Tighten the first and third bolts.

FIGURE 20

STEP 3 Tighten the remaining bolts.

STEP 4 Repeat steps 1 through 3 for the opposite side.

**+ JOHN DEERE 600 SERIES 2008-2012
360 CHAINROLL INSTALLATION COMPLETE**

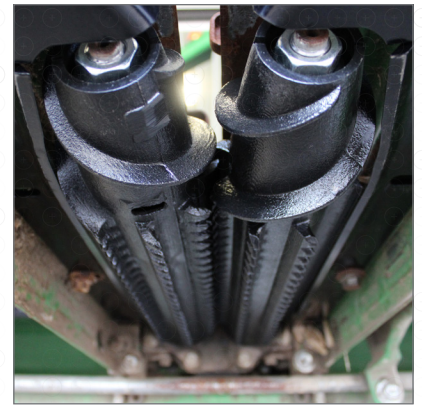

FIGURE 19



FIGURE 20

PULLER INSERT

